PRODUCT OVERVIEW

Harnessflex[®]

Fast-Fit

Harnessflex[®]
SPECIALIST CONDUIT SYSTEMS



Harnessflex®

Fast-Fit

Harnessflex® Fast-Fit represents a unique and innovative solution in flexible conduit systems - designed and recommended for use with NC Conduit.



Until now, manufacturers have produced fittings and seals separately, and assembled them together, or had the customer assemble them. This increases assembly time and introduces the possibility for errors.

Key features:

- Nylon 66 body
- Lighter in weight
- Quicker to install (cut & assemble fittings)
- Wide variety of sizes
- Better fatigue life
- Return to shape



Fast-Fit

Quick installation.

Integral face seal washer
Guaranteed fit, cannot be lost or fitted incorrectly. No assembly.

1 2

Internal elastomer conduit seal

Guaranteed fit, cannot be lost or fitted incorrectly. No assembly & protects cables.

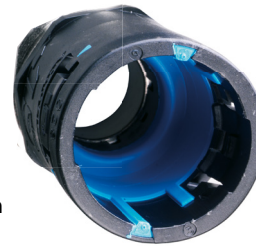

Confirmation point

Conduit data
Conduit size clearly indicated on fitting.

1/2"

Thread data
Thread size clearly indicated on fitting thread.

1

3

Visual fitting guides

Highly visible elastomer markings on lugs, aids correct fitment.

4

2

3 4

Proven clip design

Pitch independent, ensures secure fitment to coarse & fine pitch conduits.



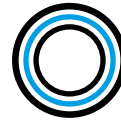

Harnessflex® Fast-Fit uses a sophisticated moulding process to mould an internal conduit seal and a face seal washer. This makes installation times very fast, and extremely reliable, because the seals cannot be left out. The conduit system also benefits from the highest IP rating possible.

The Harnessflex® Fast-Fit series provides maximum cable protection to the highest possible IP rating when used with Harnessflex NC solid conduits.

01 Harnessflex®
Fast-Fit Type A fitting.

02 Harnessflex®
Fast-Fit Type C90
fitting.

Features & benefits:

- One piece design with integrated conduit and thread sealing
- Provides continuation of cable protection between conduit and cable entry points
- High level of mechanical protection and highest degree of ingress protection against solids and liquids
- Secure conduit clip design
- Fixed external male thread for insertion into metric threaded entries or knockout holes (lock nuts included)
- Conduit and thread size indicators

Applications:

- Construction vehicles
- Agricultural machinery
- Trucks
- Heavy duty and special purpose vehicles

Material:

- Polyamide 6,6 (Nylon) body / TPE Seals
- Very high UV resistance
- Heat stabilised (Self-extinguishing, low smoke toxicity & halogen free)

Ingress protection:

- IP66 / 67 / 68 (2 bar 30 mins) / 69K

Compatible conduits:

- All Harnessflex NC conduits

Conformity:

- CE Mark to the low voltage directive
- RoHS Compliant to 2011/65/EU
- Conforms with end of life vehicle directive (ELV) EU200/53/EC

Temperature range:

- Static Long Term -50°C to +105°C
- Static Short Term (3000 Hours) -50°C to +120°C
- Dynamic Long Term -45°C to +105°C
- Dynamic Short Term (5000 operations @MBR) -45°C to +120°C

Harnessflex® Fast-Fit

Type A fittings (blue elastomer)



Fast-Fit Type A fittings (blue elastomer)

Straight fitting with a fixed external male thread (Metric or NPT)

Materials: Polyamide (nylon) 66/TPE

Colour: Black (BL) / Blue (B) Elastomer

Type A fitting (blue elastomer)

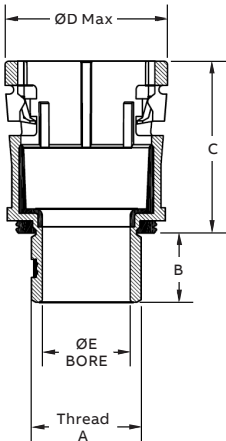
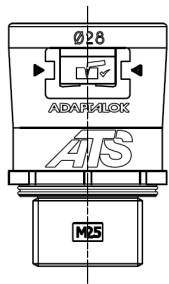

Part No. (Metric)	Metric thread A	Nominal dimensions (mm)			
		B	C	D	E
HTS12/M16/A	M16 x 1.5	11.8	34.2	21.2	11.2
HTS16/M16/A	M16 x 1.5	11.8	36.0	23.2	11.2
HTS16/M20/A	M20 x 1.5	11.8	36.0	23.2	15.2
HTS20/M20/A	M20 x 1.5	11.8	39.5	30.2	15.2
HTS28/M25/A	M25 x 1.5	15.8	39.5	37.2	20.0
HTS32/M32/A	M32 x 1.5	15.8	41.0	44.2	26.7
HTS40/M40/A	M40 x 1.5	15.8	50.8	54.2	34.0
HTS50/M50/A	M50 x 1.5	15.8	56.3	65.0	44.0

For insertion into knockouts using a locknut. Locknut supplied with METRIC thread.

Approvals



IP rating

Appropriate conduit

For use with: Type NC solid

IP40	Yes
IP65	Yes
IP68	Yes 2 bar 30mins with Solid NC Conduits
IP69	Yes

Temperature range

Static applications: -50°C to +120°C
Moving applications: -45°C to +120°C

Harnessflex® Fast-Fit

Type C90 fittings (blue elastomer)



Fast-Fit Type A fittings (blue elastomer)

90° Elbow fitting with a fixed external male thread (Metric or NPT)

Materials: Polyamide (nylon) 66/TPE

Colour: Black (BL) / Blue (B) Elastomer

Type C90 fitting (blue elastomer)

Part No. (Metric)	Metric thread A	Nominal dimensions (mm)					
		B	C	D	E	F	G
HTS12/M16/C90	M16 x 1.5	11.5	31.5	21.2	11.0	22.0	65.2
HTS16/M16/C90	M16 x 1.5	11.5	33.1	23.2	11.0	22.0	65.2
HTS16/M20/C90	M20 x 1.5	13.0	34.2	23.3	11.0	27.0	70.0
HTS20/M20/C90	M20 x 1.5	13.0	36.1	30.2	15.4	27.0	72.0
HTS28/M25/C90	M25 x 1.5	15.0	45.1	37.2	19.0	32.1	76.4
HTS32/M32/C90	M32 x 1.5	16.0	57.0	44.2	25.9	38.9	86.4
HTS40/M40/C90	M40 x 1.5	16.0	73.5	54.2	33.3	57.4	104.7
HTS50/M50/C90	M50 x 1.5	16.0	94.5	65.0	43.8	59.0	127.6

For insertion into knockouts using a locknut. Locknut supplied with METRIC thread.

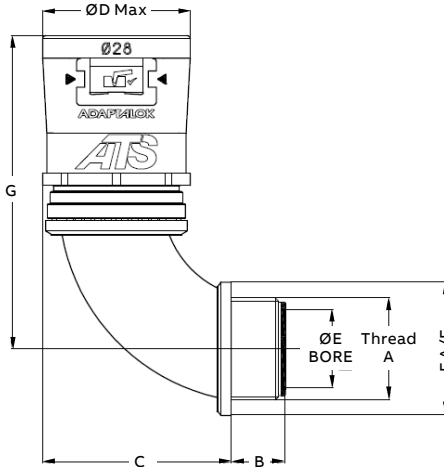

Approvals	IP rating	Appropriate conduit	Temperature range
	For use with: Type NC solid		Static applications: -50°C to +120°C
	IP40	Yes	Moving applications: -45°C to +120°C
	IP65	Yes	
	IP68	Yes	
	2 bar 30mins with Solid NC Conduits		
	IP69	Yes	

Harnessflex® Fast-Fit

Properties

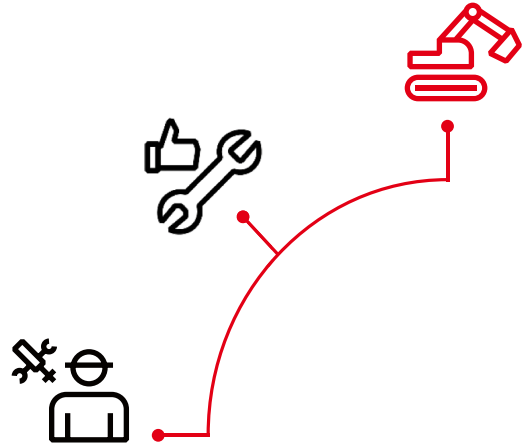

Dynamic & thermal properties

Test type	Standard	Requirement	Result
Dynamic applications	IEC61386-1	5000 Operations in 2 hours at MBR*	-45°C to +120°C
Static short term temperature		Temporary use (3,000 hours)	-50°C to +120°C
Static long term temperature		Permanent use (30,000 hours)	-40°C to +105°C

* Conduit Minimum Bend Radius (MBR)

Flammability

Test type	Standard	Requirement	Result
Glow wire	BS EN 60695-2-11	Extinguish within 30 seconds	850°C
Flammability	IEC 61386-1-12	1Kw Burner flame to self-extinguish	Pass
Oxygen index - Nylon body	ISO 4589-2	-	24.1%
Ignition rating - Nylon body	NF F16-101	I Rating	I4
Oxygen index - Elastomer seal	ISO 4589-2	-	20.2%
Ignition rating - Elastomer seal	NF F16-101	I Rating	I4

Toxicity

Test type	Standard	Requirement	Result
Halogen Free	NFX 70-100	< 0.5%	Pass

Smoke

Test type	Standard	Requirement	Result
Fume rating - Nylon body	NF F16-101	F Rating	F2
Fume Rating - Elastomer seal	NF F16-101	F Rating	F2

Pre-test conditions

Duration	Standard	Temperature	Relative humidity
168 hours	BS EN IEC61386	23°C	50%

Harnessflex® Fast-Fit
Removal tool

Fast removal
of fittings



01 Harnessflex®
Fast-Fit removal tool.

The Harnessflex® Fast-Fit Removal tool for simple, safe removal of Fast-Fit fittings.

Instructions:

1. Slide removal tool over conduit
2. Align tabs with retention clips on fitting
3. Slide removal tool into fitting, pushing the tabs underneath the clips
4. Remove fitting from conduit

Features & benefits:

- Safe and simple removal and of Harnessflex Fast-Fit fittings

Material:

- Polyamide 6
- Black

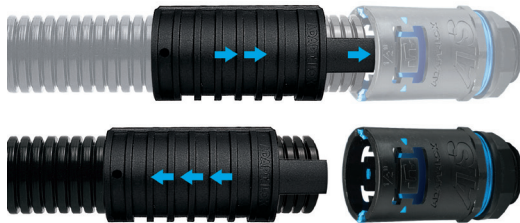

Harnessflex® Fast-Fit removal tool

	Part No.	Harnessflex Fast-Fit fitting size (mm)
	HTS12/RT	12
	HTS16/RT	16
	HTS20/RT	20
	HTS28/RT	28
	HTS32/RT	32
	HTS40/RT	40
	HTS50/RT	50



ABB Cable Management Products Ltd

CMG House
Station Road
Coleshill
Birmingham B46 1HT
Tel: +44 (0) 1675 468 200

For Sales Support contact:

gb-cmg.salessupport@abb.com

For Technical Support contact:

cmg.conduitsystems@abb.com

For Sample Support contact:

gb-sample-requests@abb.com

harnessflex.com